

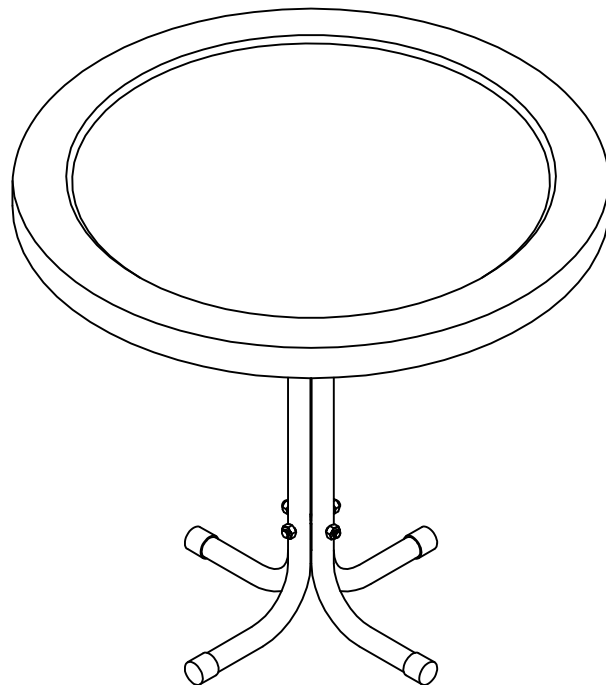







GRIFFITH METAL SIDE TABLE
CO1011A

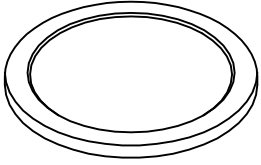

PART LIST

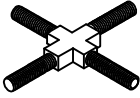
<div data-bbox="76 152 140 226" data-label="Text">1</div> 	<div data-bbox="443 152 507 226" data-label="Text">2</div> 
<div data-bbox="137 535 352 580" data-label="Text">Support Legs</div> <div data-bbox="169 624 320 674" data-label="Text">4 PCS</div>	<div data-bbox="533 535 700 580" data-label="Text">Table Top</div> <div data-bbox="564 624 676 674" data-label="Text">1 PC</div>

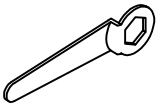
HARDWARE LIST

<div data-bbox="76 878 140 952" data-label="Text">A</div> 	<div data-bbox="443 878 507 952" data-label="Text">B</div> 	<div data-bbox="818 878 882 952" data-label="Text">C</div> 	<div data-bbox="1187 878 1251 952" data-label="Text">D</div> 
<div data-bbox="177 1261 312 1305" data-label="Text">"+"Bolts</div> <div data-bbox="169 1350 320 1400" data-label="Text">2 PCS</div>	<div data-bbox="576 1261 655 1305" data-label="Text">Nuts</div> <div data-bbox="533 1350 703 1400" data-label="Text">12 PCS</div>	<div data-bbox="911 1261 1062 1305" data-label="Text">Washers</div> <div data-bbox="903 1350 1074 1400" data-label="Text">12 PCS</div>	<div data-bbox="1294 1261 1430 1305" data-label="Text">Wrench</div> <div data-bbox="1302 1350 1422 1400" data-label="Text">1 PC</div>
<div data-bbox="76 1424 140 1498" data-label="Text">E</div> 	<div data-bbox="443 1424 507 1498" data-label="Text">F</div> 		
<div data-bbox="185 1798 312 1843" data-label="Text">Screws</div> <div data-bbox="169 1888 320 1937" data-label="Text">4 PCS</div>	<div data-bbox="528 1798 711 1843" data-label="Text">Tube Caps</div> <div data-bbox="544 1888 695 1937" data-label="Text">4 PCS</div>		

STEP 1 Attach the two Support Legs (1) using the 2 "+" bolts (A), 4 Washers (C) and 4 Nuts (B). Do not tighten until after you have completed the entire assembly process.

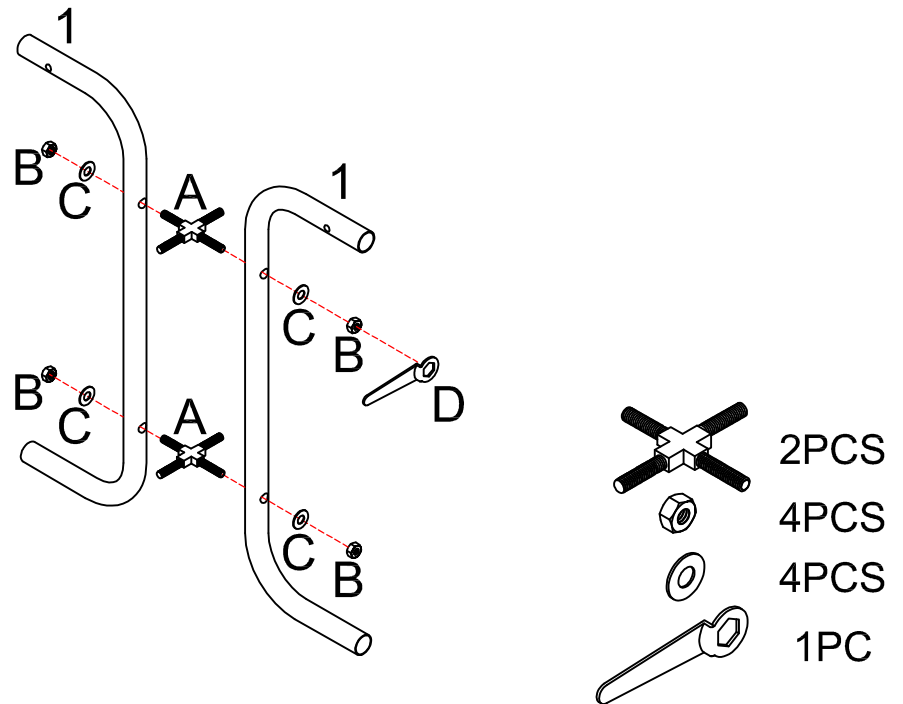

STEP 2 Attach the two remaining Support Legs (1) to the "+" bolts (A) using 4 Washers (C) and 4 Nuts (B). Do not tighten until after you have completed the entire assembly process.

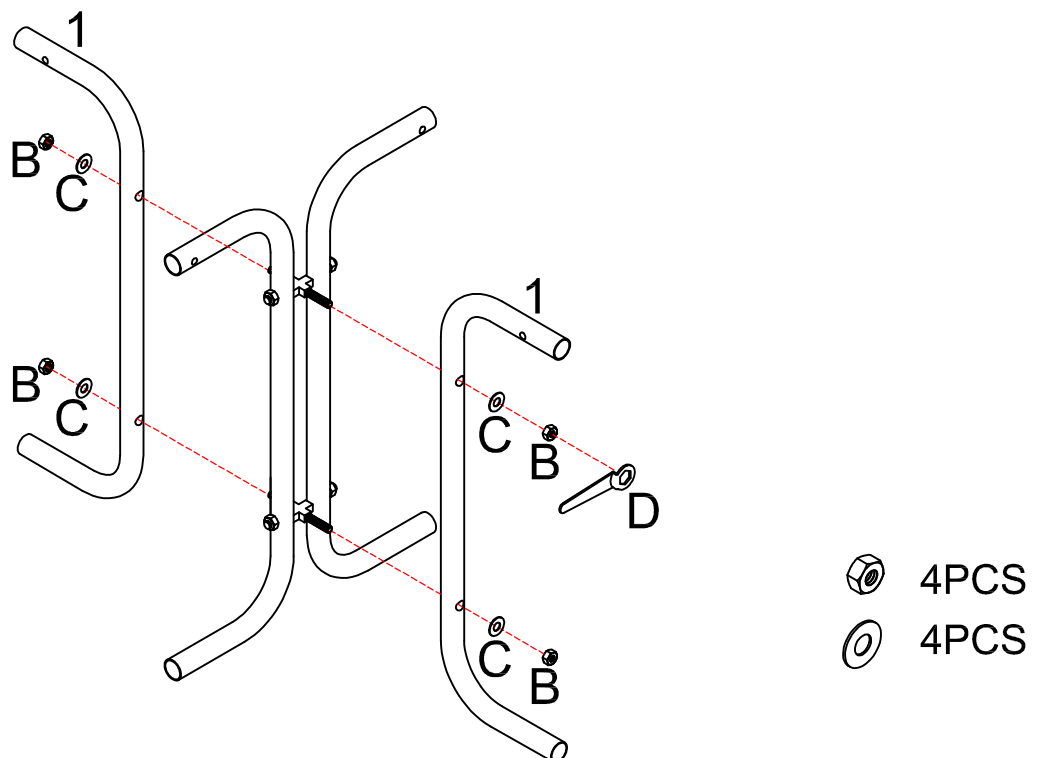

STEP 3 Attach the table top (2) to the base legs using 4 Bolts (E), 4 washers (C) and 4 nuts (B) by inserting each bolt into the bracket located under the table top and secure with the washer and nut. Repeat these steps for the remaining 3 brackets to secure the table top to the support legs.

Once assembly has been completed, you may tighten all nuts to firmly secure the patio side table. And add the Tube Cap (F) to the support legs (1).

